

Wetroom Concept

WATERPROOF SYSTEM

Complete
solution for
Wetrooms



CONTENTS

THE WETROOM CONCEPT

A COMPLETE SOLUTION FOR WETROOMS 3

DESIGNING A SAFE AND COMFORTABLE ENVIRONMENT 5

DESIGNING AN ENVIRONMENT FOR AGEING WELL 7

A COLLECTION OF COLOURS 8

A LARGE RANGE OF ACCESSORIES FOR AN ELEGANT FINISH 16

INSTALLATION PROCESS 19

FLOOR COVERING INSTALLATION 20

WALL COVERING INSTALLATION 24

TOOLS REQUIRED 27

PRODUCT DESCRIPTION 28

TECHNICAL DATA 29

REFERENCE CODES 30

GUARANTEE AND MAINTENANCE 31



WALL: AQUARELLE WALL HFS - KIRUMA GREEN - 3942 047
FLOOR: GRANIT SAFE. T BLACK GREY - 3052 699

A COMPLETE SOLUTION FOR WETROOMS

Tarkett wetroom concept offers you a complete and 100% water-resistant solution including walls, floors and accessories wherever you need it. A true specialized expert, Tarkett pioneered the wetroom concept over 35 years ago with over 1 million installations performed since then.

The Tarkett wetroom concept is designed to create a unique atmosphere in healthcare and aged-care facilities, but also in collective housings and hospitality applications.

More than **35 years** of experience

Full concept **100% water-resistant system** (walls, floors and accessories).

 **27 wall and 55 floor patterns to mix & match**

Safe
Protection from slips and falls.
Class B & C slip resistance floors (according to norm DIN 51097)

Healthier interior
contributes to optimal indoor air quality



 **100% phthalate-free**

 **<10 µg/m³**
Optimal Indoor Air Quality
*TVOC AT 28 DAYS

 **Hygienic and clean**
Fewer joints, easy to cove & hot weld.



DESIGNING A SAFE AND COMFORTABLE ENVIRONMENT

 Slip resistance	 Visual comfort	 Easy cleaning
--	---	--

Slip resistance

Our wetroom flooring solutions provide confident grip for bare feet and reduce the risk of slipping, even when covered in soap and water.

BAREFOOT SLIP RESISTANCE (DIN 51097)

	Anti-slip technology	Class B (shower room, changing room) angle >18°	Class C (constantly under water), angle >24°
GRANIT MULTISAFE	Studs		✓
GRANIT SAFE.T	Anti-slip particules	✓	
OPTIMA MULTISAFE	Studs	✓	
MULTISAFE AQUA	Specific embossing		✓

Healthier interior

contributes to optimal indoor air quality

 **100% phthalate-free**

 **<10 µg/m³**
Optimal Indoor Air Quality
*TVOC AT 28 DAYS

Hygienic and clean



Priority hygiene & effortless maintenance



- Fewer joints
- Hot welded installation from floor to wall
- High flexibility to cover corners
- Resists stains
- Easy to clean

Mix & match



27 wall and 55 floor patterns to mix & match

- Mix and match: floors & walls design possibilities are endless
- Coordinated design from the wetroom through adjoining rooms
- With colours matching with other Tarkett ranges (Platinum, Excellence, ProtectWall)

Exclusive designs that create unique environments.



WALL: AQUARELLE WALL HFS - VOGUE LIGHT WARM GREY - 3942 052
 FLOOR: MULTISAFE AQUA - CONCRETE WARM GREY - 25910 008
 EXCELLENCE - UNI DARK GREY - 25131 916

DESIGNING AN ENVIRONMENT FOR AGEING WELL

Many aged-care facilities today cater for people living with dementia alongside residents who face other age-related difficulties. It is therefore important to design aged care facilities with dementia in mind.

People with dementia typically experience memory problems, have difficulty processing information and are less able to communicate. The condition also impacts their perception of their surroundings, leaving them unable to relate what they see to physical reality or to perceive objects in three dimensions. These difficulties can generate stress and anxiety. **Ensuite shower room should be designed to promote a sense of wellbeing, encouraging dignity and familiarity, whilst observing independence and security**



Create a home like feeling

Comfort is the key word when welcoming a person into their new home. Familiar designs with subtle patterns or textures will contribute to avoiding an institutional feeling. Particular attention should be paid to the choice of designs. Avoid busy patterns which may be misinterpreted and can cause anxiety for people living with dementia.

USE Plain patterns, material effects with subtle pattern



Stone
Warm Grey 3942 041



Granit Safe. T
Beige 3052 702

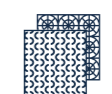

Avoid busy patterns, dark colours and high-contrast designs



Bubbles
Brownb 3942 061



Terrazzo
Green 25910 011



Dementia friendly designs* are flagged with:  on pages 8 to 15.

*Designs rated 1a-1b by University of Stirling's Dementia Services Development Centre (DSDC)

1a: Finishes within this rating are plain and can be used indiscriminately.

1b: Finishes within this rating are semi-plain (minimal texture or fleck and / or minimum contrast between fleck / pattern, wood effect with no knots) and in general, can be used throughout.









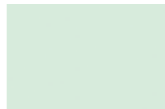

Use Light Reflection values (LRV) to create contrast

Use **strong contrast** between floors and wall and between walls and sanitary equipment to enhance visual perception:
LRV difference > 30 points.

Use **low contrast** for a smooth transition from bedroom to the wetroom:
LRV difference < 10 points.

Recommended floor and wall associations

Walls	Floors	Bedroom floor
 Green Celadon 3942 076 LRV = 67	 Granito Warm Grey 25910 009 LRV = 37	 Excellence Oak Longstripe Natural 25127 002 LRV = 30
 Vogue Light Beige 3942 054 LRV = 56	 Concrete Warm Grey 25910 008 LRV = 19	 Excellence Brushed Oak Medium 25132026 LRV = 14
 Stone Medium Grey 3942 044 LRV = 10	 Granito Cool Grey 25910 010 LRV = 41	 Excellence Tissage Soft Light Blue 25128 130 LRV = 33

A COLLECTION OF COLOURS

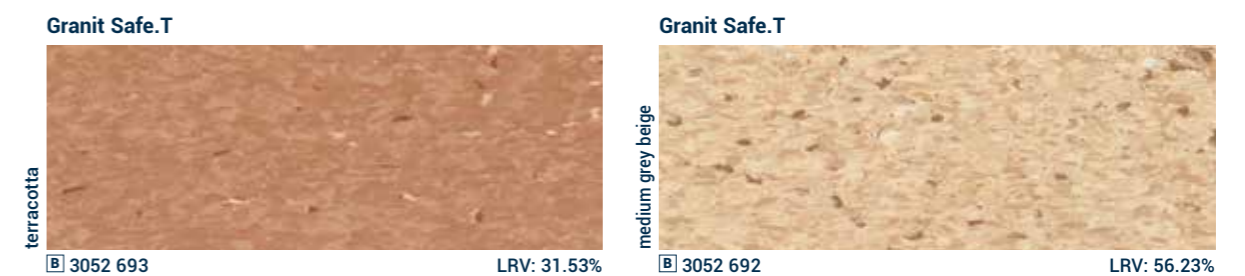
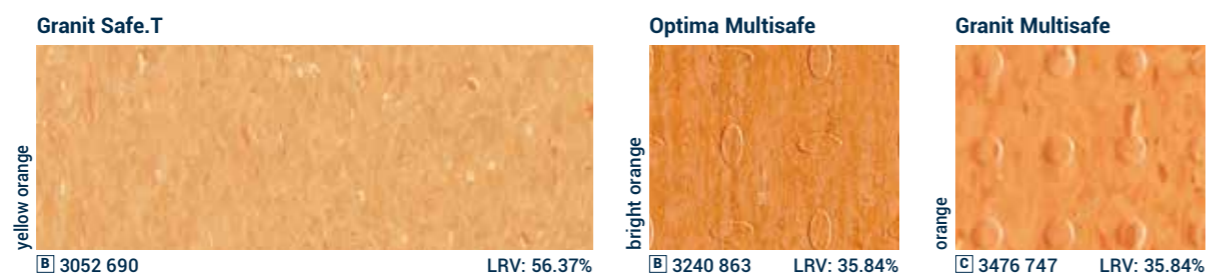
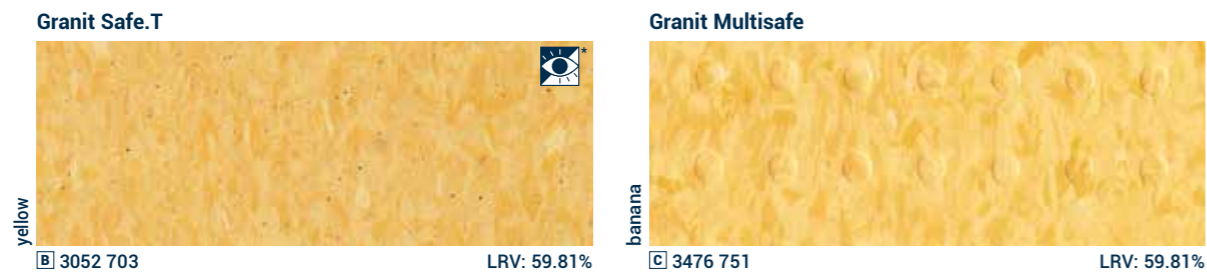
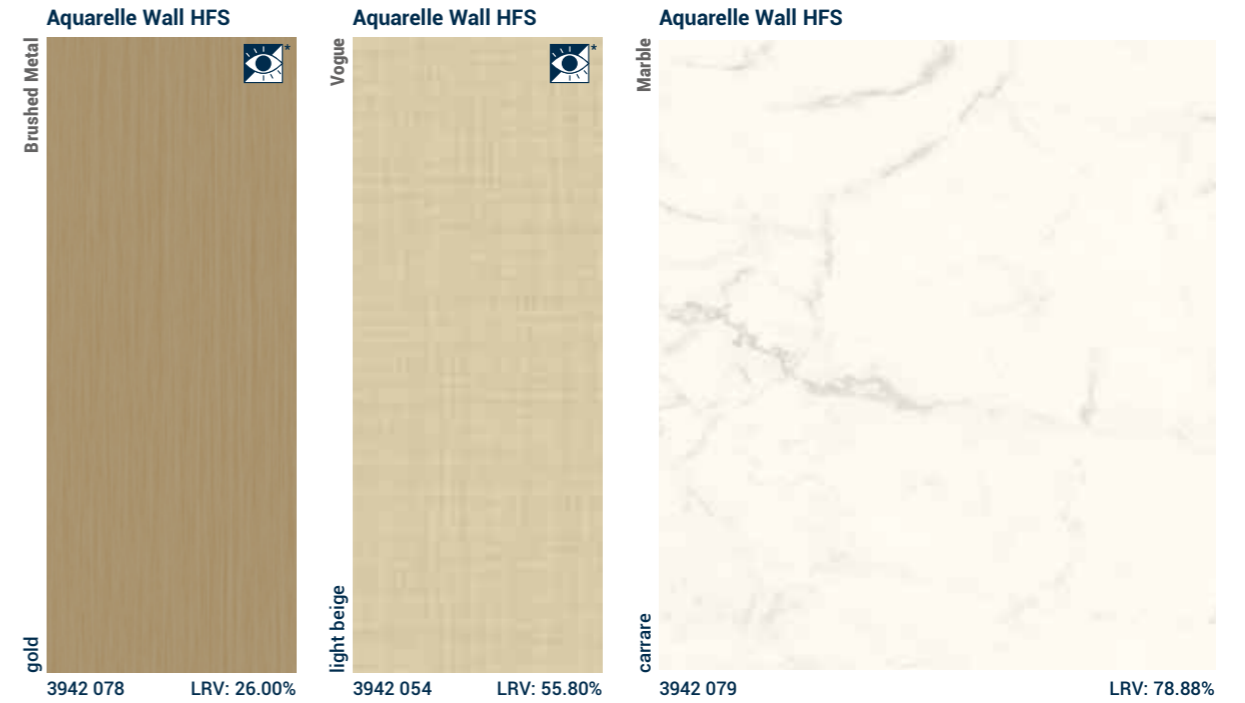
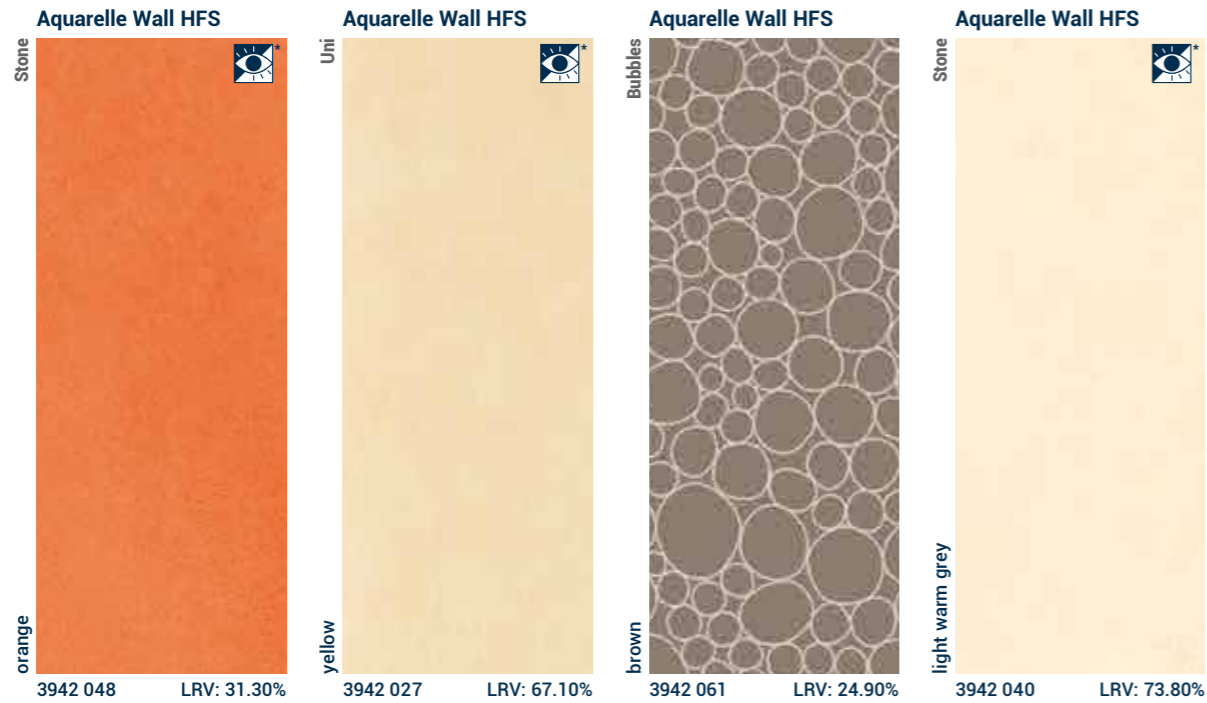

BARE FOOT TEST: Class B (18°) / Class C (27°).  Dementia friendly designs, see page 7

BARE FOOT TEST: Class B (18°) / Class C (27°).  Dementia friendly designs, see page 7

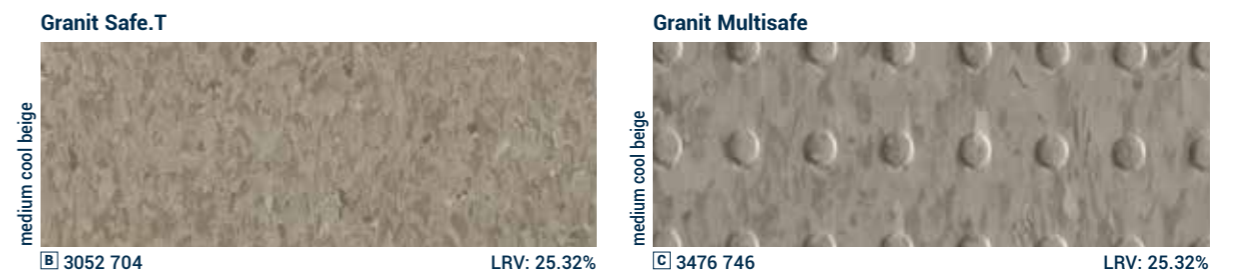
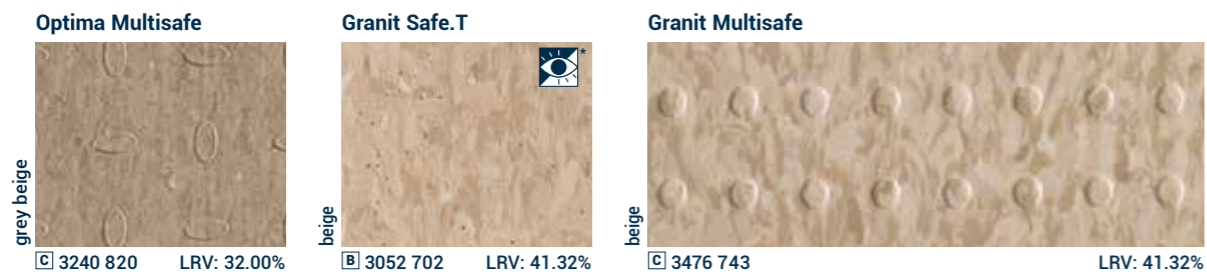
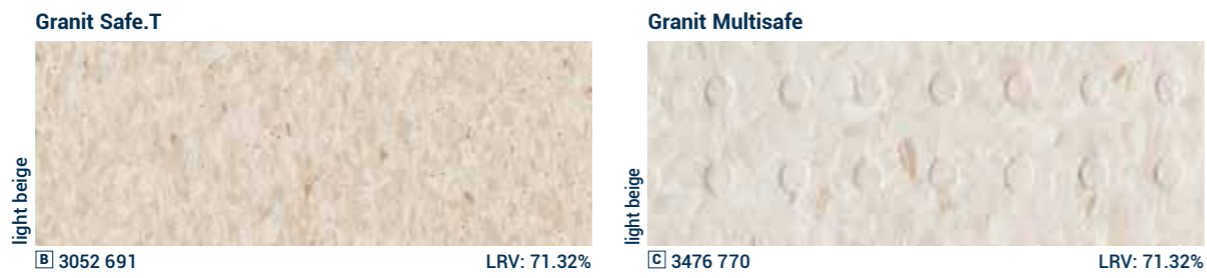
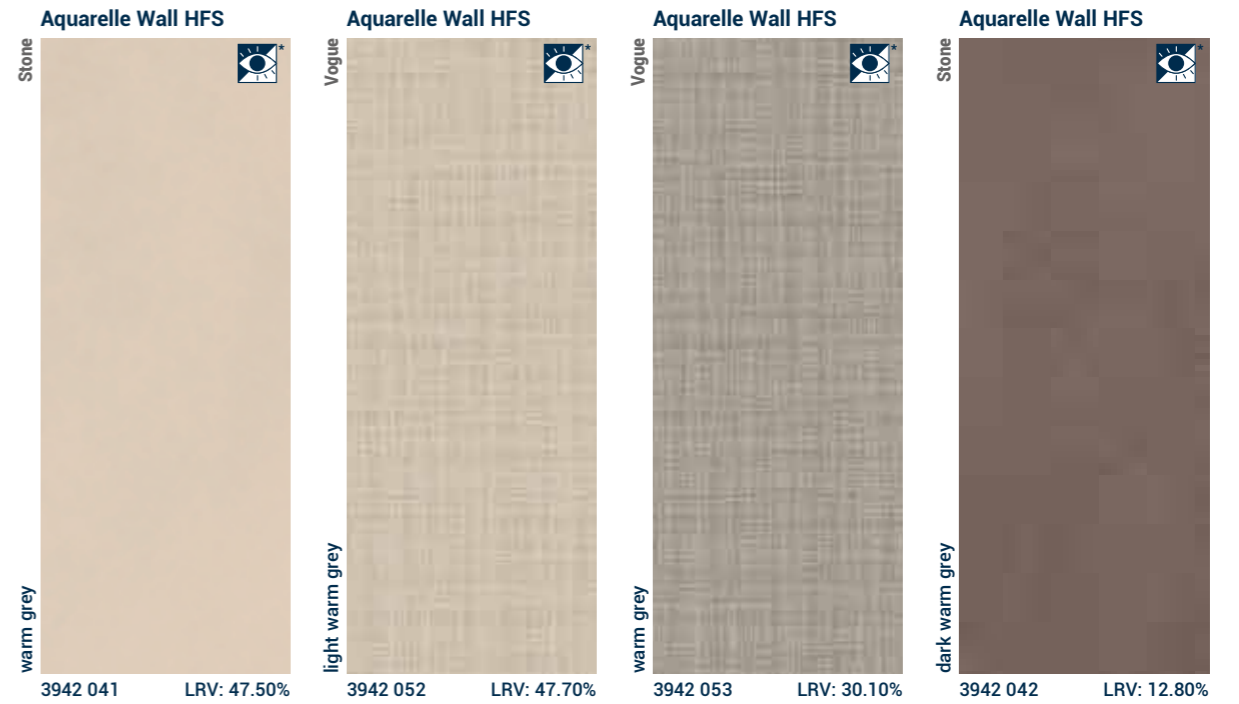
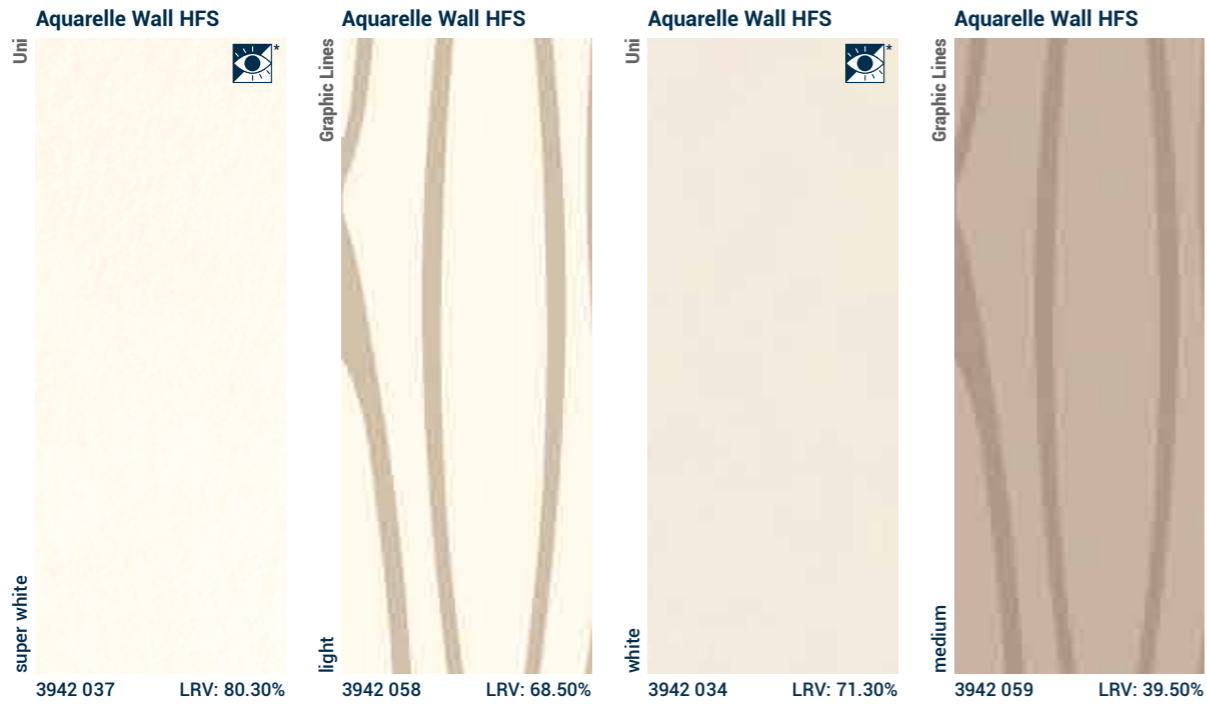

BARE FOOT TEST:  Class B (18°) /  Class C (27°).  Dementia friendly designs, see page 7

BARE FOOT TEST:  Class B (18°) /  Class C (27°).  Dementia friendly designs, see page 7

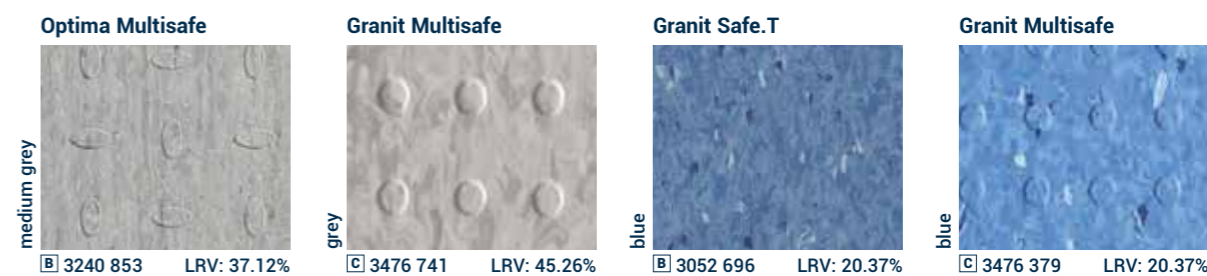
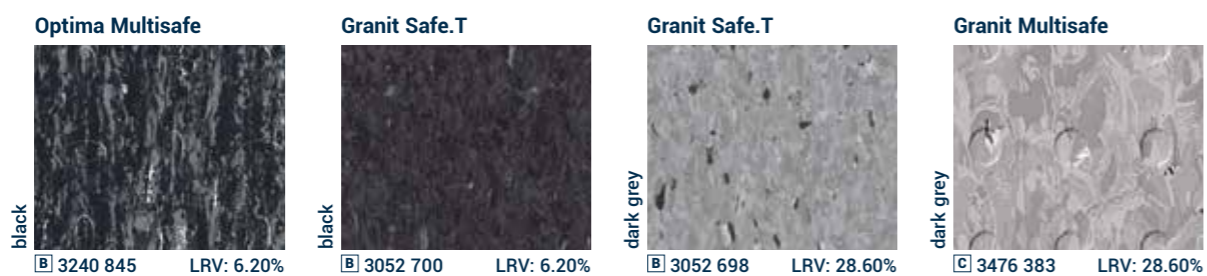
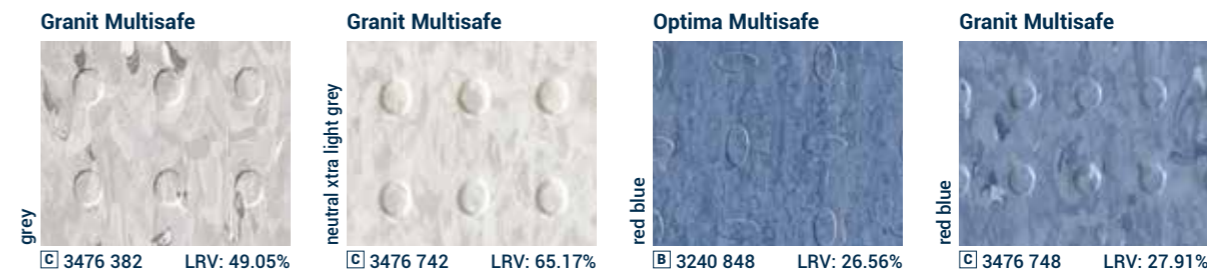
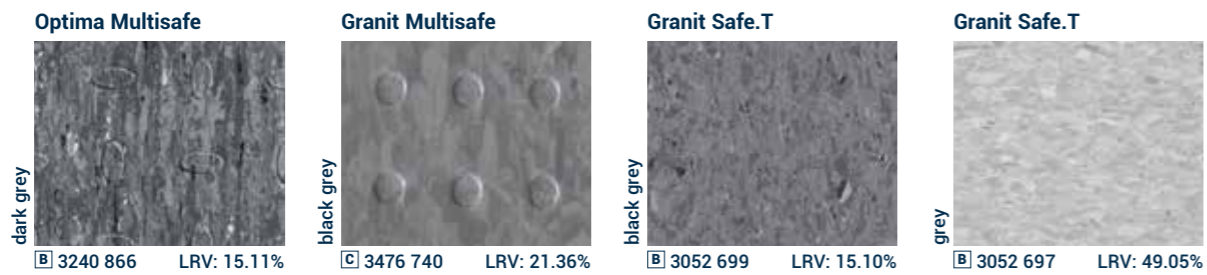
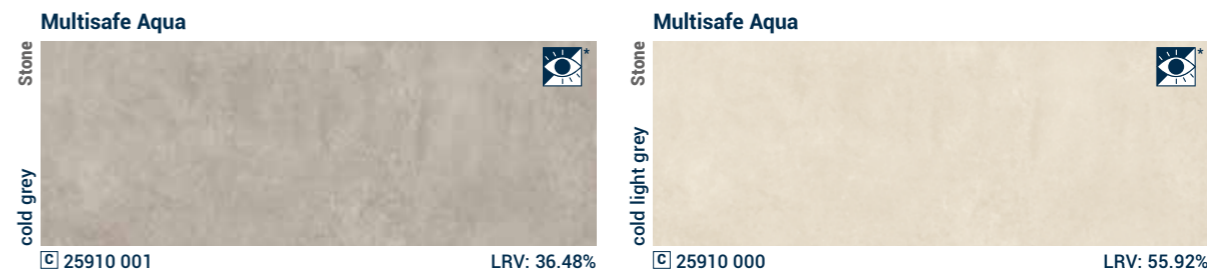
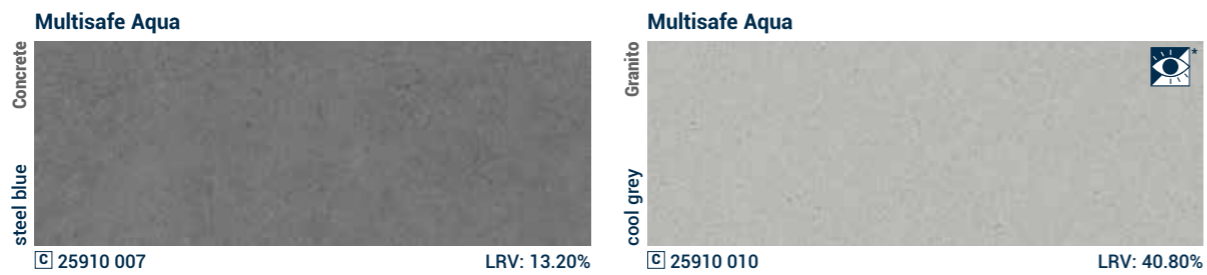
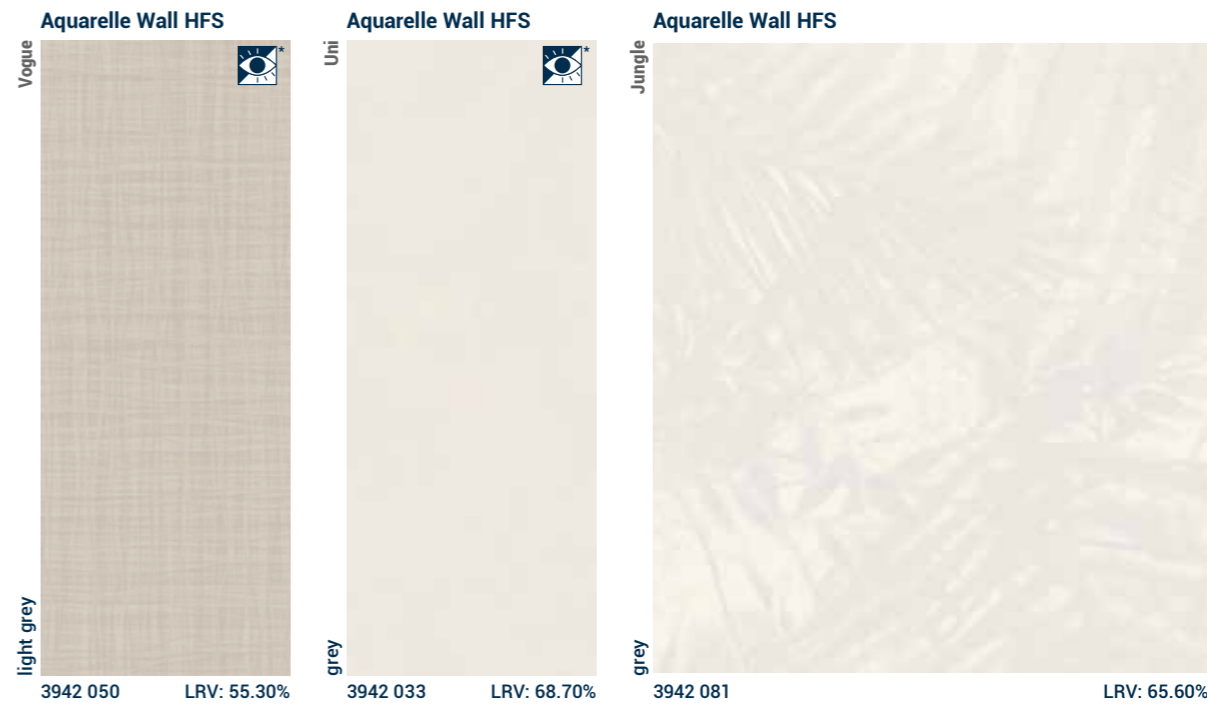
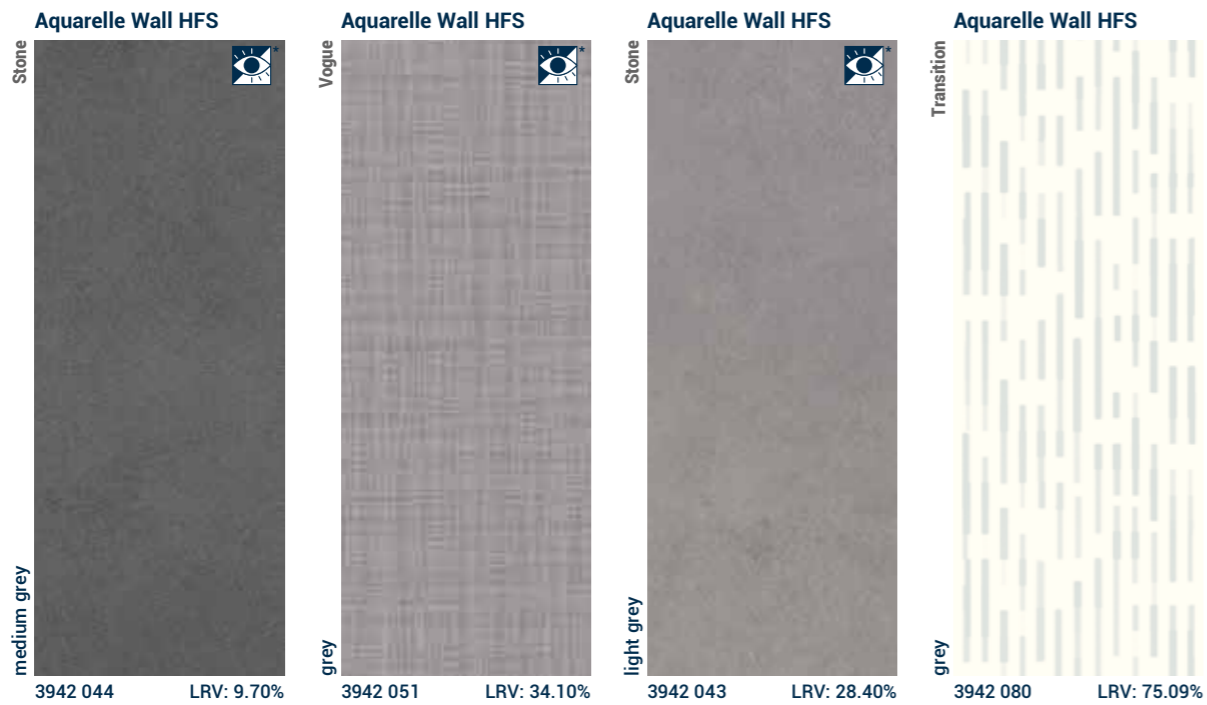

BARE FOOT TEST:  Class B (18°) /  Class C (27°).  Dementia friendly designs, see page 7

BARE FOOT TEST:  Class B (18°) /  Class C (27°).  Dementia friendly designs, see page 7

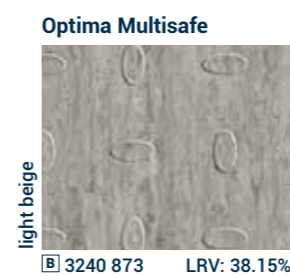
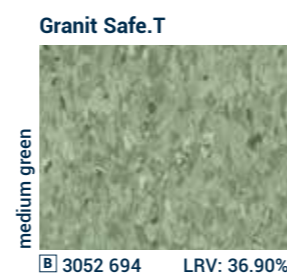
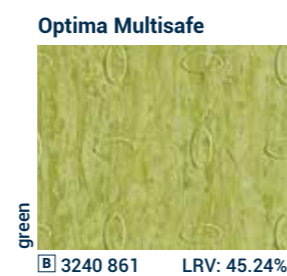
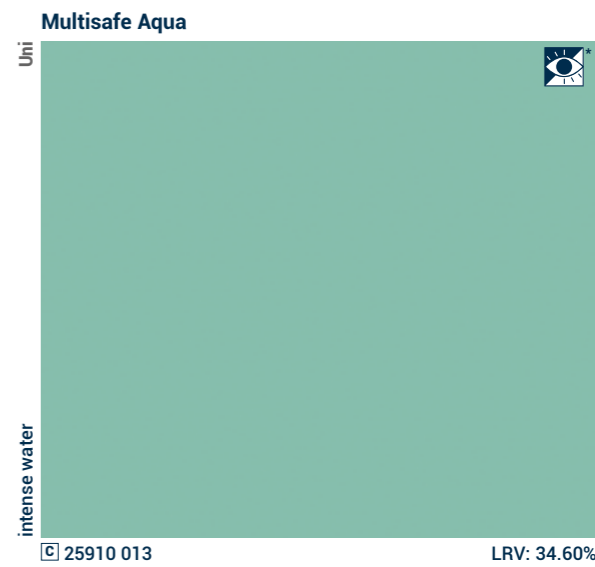
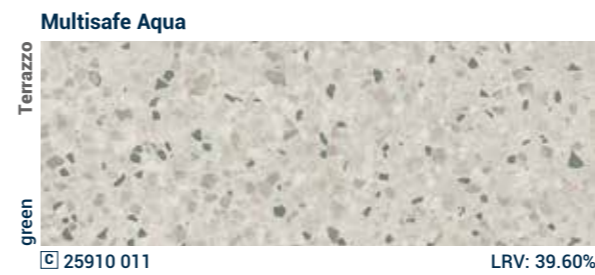
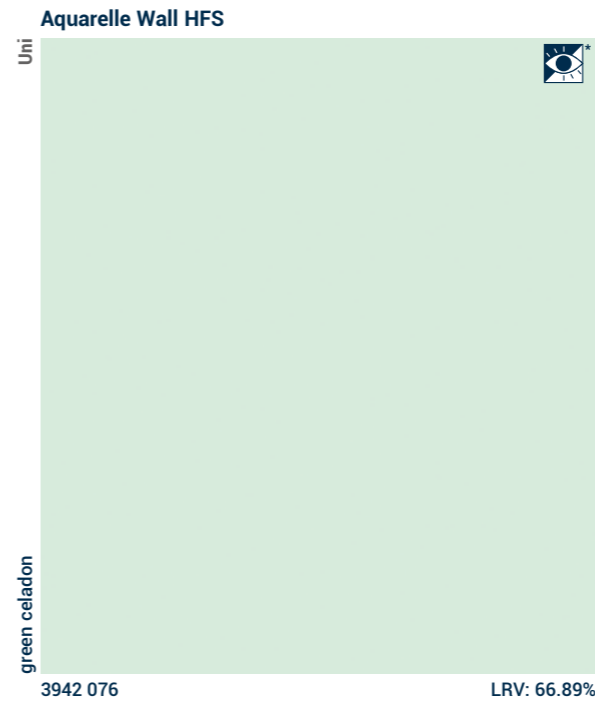
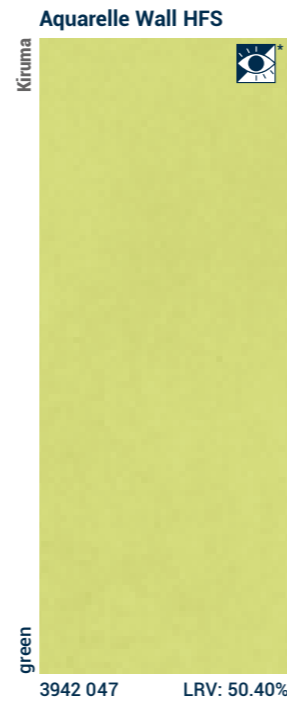
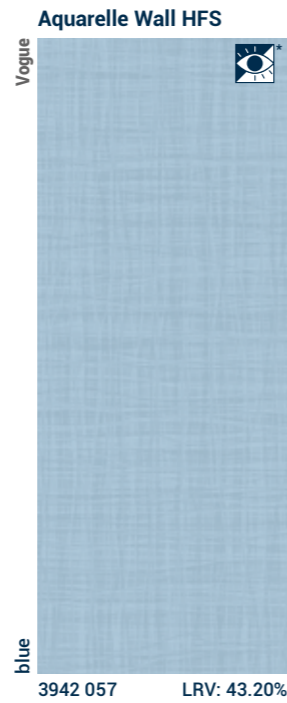
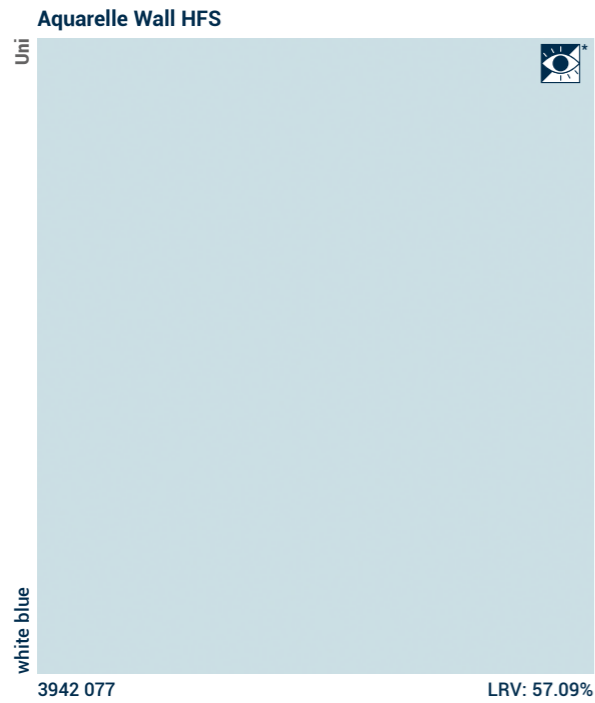

BARE FOOT TEST: Class B (18°) / Class C (27°). Dementia friendly designs, see page 7

BARE FOOT TEST: Class B (18°) / Class C (27°). Dementia friendly designs, see page 7

A LARGE RANGE OF ACCESSORIES FOR AN ELEGANT FINISH

It's the accessories that can make all the difference with an elegant finish.

Tarkett provides a wide range of accessories to complete the Wetroom Concept.



COVE FORMERS AND PROFILES

1 Cover formers PA15, PA20 & PA30

PA15
For added hygiene inside wall corners

PA20 & PA30
For added strength at the most vulnerable point between wall and floor

References
PA 15 (15x15 mm) / ref. 2661 7001
PA 20 (20x20 mm) / ref. 1441 000
PA 30 (30x30 mm) / ref. 1442 000

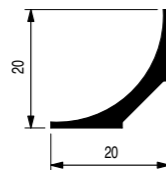

2 Flexible junction profiles PJ30 & PJ65

Designed to ensure a perfect watertight seal between covered floor covering and wall covering

References
PJ 30 (30 mm) / ref. 1418 001
PJ65 (65 mm) / ref. 2666 1001

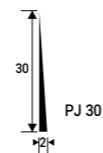

3 Threshold transition RTS & PTS

- exists in flexible rubber version (RTS)
- exists in rigid PVC version (PTS)

References

RTS Available in one colour
Grey / ref. 1255 748

PTS Available in four colours
Grey / ref. 2666 4001
Dark grey / ref. 2666 4002
White / ref. 2666 4003
Beige / ref. 2666 4004

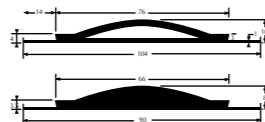

A RANGE OF ADAPTED DRAINS

4 PVC and stainless steel drains and gratings

- Large selection of siphons
- Several models of PVC gratings
- Several models of INOX gratings

CLASSIC DRAINS

VERTICAL OUTLET Four models

SIPHON PURUS BRAGE 75
ref. 1416 005 outflow 0.8L/s

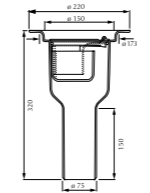

SIPHON PURUS BRAGE 50
ref. 1416 004 outflow 0.8L/s

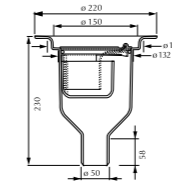

SIPHON INOX 40*
ref. 1416 007 outflow 0.66L/s

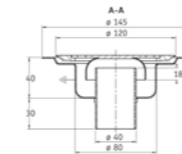

SIPHON PURUS DUSCHBRUNN 50
ref. 1416 001 outflow 0.8L/s

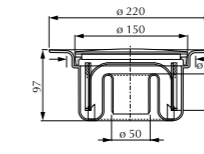

SAFE
ref. 1416 014 outflow 0.4L/s



HORIZONTAL OUTLET Three models

SIPHON PURUS FREJA 50
ref. 1416 002 outflow 0.8L/s

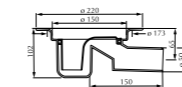

SIPHON PURUS ODEN 75
ref. 1416 003 outflow 0.8L/s

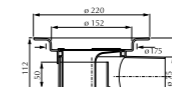

SIPHON MINIMAX
ref. 1416 006 outflow 0.8L/s



MINIMAX S-SERIE
ref. 1416 013 outflow 0.5L/s
(not recommended for connection of baths)



GRATINGS

PVC

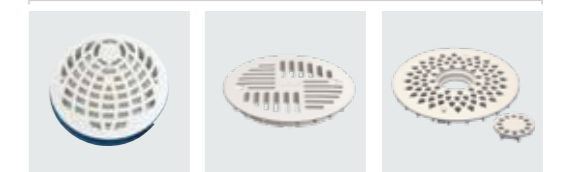

Standard 1417 001
Art Deco 26658 001
Drop Grating "Drop" with hole for pipe 26657 001



Hole for pipe 26659 001
Hole for pipe 26660 001
Grating S-Serie Minimax 26660 002

INOX



Wave 26653 001
Wave 26652 001
Drop 26651 001



Drop 26650001
Art deco 1417 013
Art deco 1417 010



Grating S-Serie Minimax 26650 002

PURUS ITEMS



Brage/Oden water trap 1417 005
Freja water trap 1417 007
Locking set 1417 006



Duschbrunn water trap 1417 008
Support 1417 004
Purus knife 1417 003



Clamping ring: 150mm 1417 002

Extra blades for Purus knife (x5)
Purus Safe knife 1417 023

A RANGE OF ADAPTED DRAINS

RECTANGULAR DRAINS



Dimensions
Length: 600, 900mm
Width: 130mm
Note that the height depends on which gully you choose

Bottom outlet



Side low outlet



Side outlet

TARKETT MATERIAL DESCRIPTION

26687101	Siphon Vinyl Plus Chess Ø50 side 600mm
26691101	Siphon Vinyl Plus Chess Ø50 side low 600mm
26689101	Siphon Vinyl Plus Chess Ø75 side 600mm
26688101	Siphon Vinyl Plus Chess Ø75 bottom 600mm
26693101	Siphon Vinyl Plus Chess Ø50 side 900mm
26697101	Siphon Vinyl Plus Chess Ø50 side low 900mm
26695101	Siphon Vinyl Plus Chess Ø75 side 900mm
26694101	Siphon Vinyl Plus Chess Ø75 bottom 900mm

WALL BORDERS

2590 0034 White
Thickness: 0.92 mm
Roll length: 30 - 35 lm

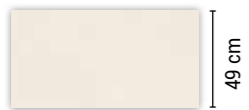

49 cm

2590 0037 Extra white
Thickness: 0.92 mm
Roll length: 30 - 35 lm

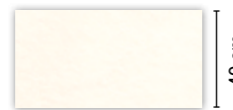

49 cm

WATERPROOF PIPE COLLARS

Offer an efficient way to achieve a watertight finish for small diameter pipework in a variety of sizes



STOSETT LOW TOP MEMBRANE

Diameter*	Reference	Packaging
8 - 12 mm	1420 001	24 sleeves + 12 clamps
11 - 15 mm	1420 002	24 sleeves + 12 clamps
15 - 19 mm	1420 003	24 sleeves + 12 clamps
18 - 22 mm	1420 004	24 sleeves + 12 clamps
21 - 26 mm	1420 005	24 sleeves + 12 clamps
26 - 31 mm	1420 006	24 sleeves + 12 clamps
30 - 35 mm	1420 007	24 sleeves + 12 clamps
35 - 42 mm	1420 008	6 sleeves + 3 clamps
100 - 127 mm	1420 009	1 sleeve
Adhesive for Stosett	1460 100	1 tube = 160 ml

* The first figure indicates the diameter of the upper part; the second indicates the diameter at the groove.

WELDING RODS

Plain and multicolour welding rods to complement chosen floor coverings. Please refer to chart on page 30 for more details.

WETROOM CONCEPT INSTALLATION PROCESS

This section of the brochure gives you a step-by-step installation guide for the Wetroom Concept including floors, walls and main accessories.



WALL COVERING INSTALLATION
p 24

DRAIN INSTALLATION
p 20

FLOOR COVERING INSTALLATION
p 20

FLOOR COVERING INSTALLATION

DRAIN INSTALLATION

The drain should be installed by a qualified plumber as part of the wetroom installation and according to the instructions provided with the drain and the recommended installation standards.



FLOOR COVERING INSTALLATION (11 STEPS)

The Wetroom Concept includes 3 types of homogeneous vinyl flooring:

- Multisafe Granit
- Granit Safe. T
- Multisafe Optima

One type of heterogeneous vinyl flooring:

- Multisafe Aqua

The subfloor must be smooth, level, clean, dry, structurally sound, moderately absorbent and not exposed to high humidity. The preparation / dryness of the subfloor and installation procedures should all be as per the current relevant building standards within the country of use.

INSTALLATION STANDARDS

The floor must have a $\geq 1\%$ slope towards the drain.

Where the design does not include screens or other barriers to contain the water, the sloped area should include the entire zone exposed to water, that is at least 1.8 meters from the shower attachment and the drain.

Fixed or mobile, vertical screen(s) at least 1.8 meters high can be used to contain spray from the shower. In this case, the sloped area should include:

- The entire shower zone inside vertical screen(s).
- All unprotected areas exposed to water, that is at least 1.8 meters from the shower attachment and the drain.

The drain must be 30 cm from the walls.

The pipework should not diminish the integrity of the floor covering. A suitable casing (or STOSSET collars for renovations) should be provided if this is not possible.

Please see page 18 for STOSSET details.

1 PREPARING THE SUBFLOOR

The PVC flooring requires a subfloor with a minimum slope of 1 cm per meter.

Check the subfloor for humidity level, surface cohesion, porosity, flatness, curing compound, and cracks.

When a floor covering is used with a traditional mortar or concrete floor, the humidity content must not be over 4.5%, using a calcium chloride test kit to a minimum depth of 4 cm.

Where micro cracks ≤ 0.3 mm exist, use a primer recommended by the manufacturer before applying the screed.

There should be no expansion joints in the area.

2 GLUING THE COVE FORMERS

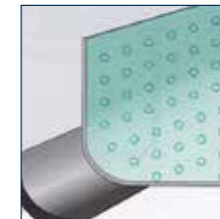

Apply cove former around the entire edge of the room, double gluing with or using an appropriate dry tape and scribe the edges around the doorframe.

3 INSTALLING THE FLOOR COVERING

Measure the sections of floor covering taking care to include enough material to cover the cove formers. 24 hours before installation, cut the appropriate lengths and store at a minimum ambient temperature of 15°C. During gluing, the sub floor temperature must be $\geq +12^\circ\text{C}$.

4 TRACING THE COVING

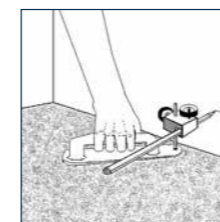

Use a scribe (Refer to code 11, p. 23) to mark all round the walls to a minimum height of 10 cm or 13 to have 7cm or 10cm coving.

5 MARKING UP THE SECTIONS

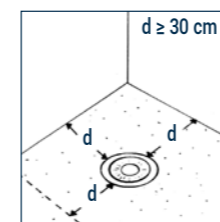

The drain must be located a minimum of 30 cm from the walls and should be installed by a plumber in accordance with Tarkett and Purus technical specifications and in accordance with the local standards.

Sections reversed: all welded joints must be at least 30 cm from the drain.

6 INSTALLATION

Lift the the part of flooring that covers the drain and install the base (foot) of the PURUS knife (see p. 17) in the gully.

Apply an acrylic adhesive recommended by Tarkett to the subfloor using a TKB A2 fine-toothed spatula (about 300g/m²). Allow the glue to become tacky and then position the floor covering section or sections. Rub down carefully. Repeat with the other pieces.

Do not apply adhesive over the drain.



7 INSTALLING THE DRAINCLAMPING RING

1 When the floor covering is in place, press it down until it is perforated by the pivot of the PURUS knife (see p. 13). Attach the arm of the knife and cut the hole in the vinyl.

2 Remove the cutter.

3 Use a hot air gun (Refer to code 1, p. 23) to heat the floor covering so that the flooring can be positioned properly in the drain.

4 Place the clamping ring (blue) on the floor covering and push to fix in the drain. Put the protective grating in place (filter).



8 COVING

1 Use a corner roller (Refer to code 2, p. 23) and hot air gun (Refer to code 1, p. 23) to make sure that the floor covering is smooth and pushed well into the floor/wall angle.

Cove the flooring by double gluing the subfloor and the back of the floor covering, applying an acrylic double contact adhesive with a spatula or use an appropriate dry tape. Carefully follow the safety requirements for this type of glue and observe the tack time.

2 Once the glue has become tacky to the touch, fold the floor covering onto the wall.

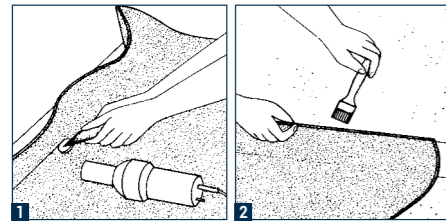

INSIDE CORNER (A)

3A Trim the excess material starting in a corner 5mm from the floor.

4A Use the corner roller (Refer to code 2, p. 23) to apply the floor covering in the corner.

5A Make a 45° cut using a set square or angle (Refer to code 10, p. 23).

Trim the coving to 10cm or 13cm to have 7cm or 10cm coving using a combined scribe/ mixed marking gauge (Refer to code 11, p. 23) or a suitable rule and cutting tool.

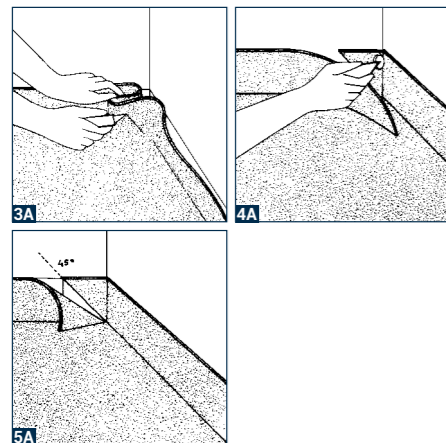

OUTSIDE CORNER (B)

3B Cut out a triangular section from the floor covering at 45° either side of the corner using an angle (Refer to code 10, p. 23) if required.

4B The triangle must finish 5mm from the floor.

5B 6B Adjust the size of the cutaway piece, cut a groove into the back and apply glue to the before applying to the corner space.

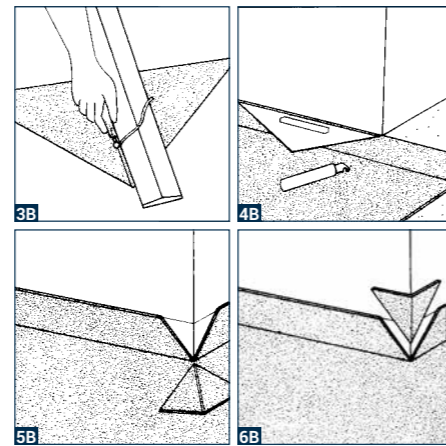

9 HOT WELDING

We recommend leaving the floor for 24-48 hours after installation before welding.

1 Welding the coving. Scribe the cuts and joints using a hand groover or adjustable groover (Refer to code 3, p. 23). T

2 Use welding rods to weld the floor joint(s). Use a speed nozzle (Refer to code 5, p. 23) and trim the welding rod with a tool designed for studded flooring (Refer to code 9, p. 23).

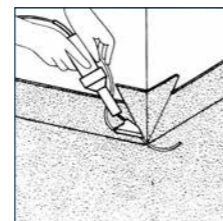

10 INSTALLING STOSETT WATERPROOF PIPE COLLAR

Wherever possible the project design should maintain flooring integrity by grouping vertical outlets in a pipe or casing along the partition.

A watertight finish is always possible for small diameter piping providing that: there is sufficient space (5 cm between and behind the pipes); special protection using collars after the floor covering has been installed.

Before installing the collar, the cuts (floor and wall) should be hot welded and the area around the pipes trimmed (depending on the STOSSET collar diameter).

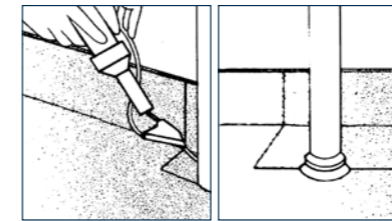

The following diagrams show the different stages:

1 Remove the RADONIX membrane at the base of the pipe work.

2 After cutting the collar, apply the adhesive (or liquid solder cold welding such as Werner Müller) around the base.

3 Position the collar and glue the joint (Werner Müller).

4 Adjust the clamping ring to keep the collar in place while the liquid solder dries.

5 Remove the ring.

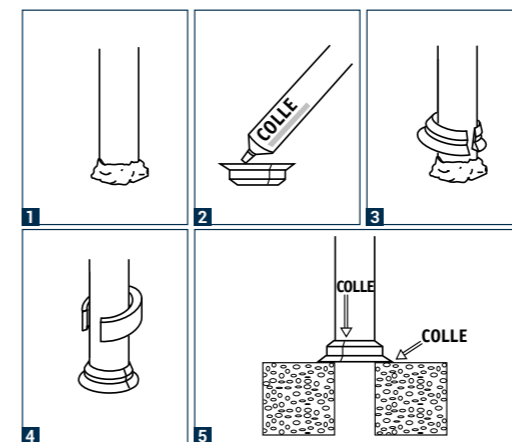

STOSETT LOW TOP MEMBRANE		
Diameter*	Reference	Packaging
8 - 12 mm	1420 001	24 sleeves + 12 clamps
11 - 15 mm	1420 002	24 sleeves + 12 clamps
15 - 19 mm	1420 003	24 sleeves + 12 clamps
18 - 22 mm	1420 004	24 sleeves + 12 clamps
21 - 26 mm	1420 005	24 sleeves + 12 clamps
26 - 31 mm	1420 006	24 sleeves + 12 clamps
30 - 35 mm	1420 007	24 sleeves + 12 clamps
35 - 42 mm	1420 008	6 sleeves + 3 clamps
100 - 127 mm	1420 009	1 sleeve
Adhesive for Stosett	1460 010	1 tube = 160 ml

* The first figure indicates the diameter of the upper part, the second indicates the diameter at the groove.

NOTE

If there is no equivalent collar for unusual diameter pipework, create one from the floor covering (welded to the base and vertically at the junction) or use a suitable caulking mastic (polyurethane or MS polymer, ref. Bostik MS 107).

11 INSTALLING EQUIPMENT (AFTER COMPLETION)

Our 10-year floor and wall guarantee only covers attachments for accessories and sanitary equipment (required for the plumbing) if suitable fixings are used. Screws must only be used with watertight chemical rawlplugs or rawlplugs with a suitable waterproof mastic (polyurethane or MS polymer, ref. Bostik MS 107).

Waterproof mastic must also be applied where surfaces meet, in particular: basin, lavatory, wall-mounted flush, grab rail, trap, etc.

Example: to install a lavatory (preferably with wall-mounted flush) follow the instructions above and before putting it into place also apply waterproof mastic where it will meet the wall.

The supporting framework and partition must be sufficiently rigid to prevent movement when the lavatory is used, which could damage the wall covering.

WALL COVERING INSTALLATION

WALL COVERING INSTALLATION (8 STEPS)

1 PREPARING THE WALLS/SUBSTRATE

It must be flat, solid, sound, dry, clean, normally absorbent and also crack-free. Any old coverings must be removed first. Apply a primer suitable for the material and then the glue (never use paint even diluted). Incoming and outgoing pipes should have a maximum diameter of 5 cm. A 5 cm gap must be left between the pipework and the wall to leave room to hang Aquarelle Wall HFS.

2 PREPARING THE WALL COVERING

Precut 24 hours before gluing and keep at a minimum ambient temperature of + 15°C.

3 INSTALLING THE FLOOR/WALL TRANSITION STRIP (REF. PJ 30 & PJ 65)

Apply a PJ 30 transition strip to compensate for the thickness of the coving, double gluing with an acrylic double contact adhesive with a spatula or use an



appropriate dry tape. It is also possible to apply a wall leveling compound instead of the PJ30.

4 INSTALLING THE WALL COVERING

The wall covering should be installed so that the joints are as far away from the wet zone as possible and at least 10 cm from a corner. Joints should never be made in a corner. Measurements should include a minimum extra 3 cm to overlap the coving.

Before installing the wall covering, remove the studs with a quarter moon knife. This allows a smoother finish when creating the coving up and overlapping wall covering over the floor covering by 3 cm.

VERTICAL INSTALLATION

Position the sheets vertically to room height (reversed when necessary).



HORIZONTAL INSTALLATION

Aquarelle Wall HFS can be installed horizontally, but a Wall Border (49 cm width) must be used to ensure that the full height of the room is watertight. The Border should be applied once the Aquarelle Wall HFS wall covering is in place, and should overlap the upper edge by at least 2 cm (only use acrylic adhesive). The Wall Border frieze is positioned on the bottom edge for the best visual effect.



Wall borders

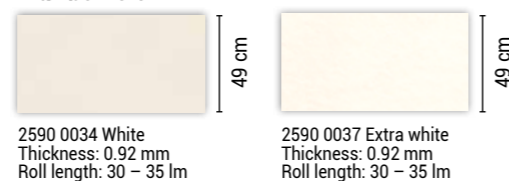

5 GLUING

Take the full width of a floor covering section and mark a plumb line on the wall from ceiling to coving. Use a fine-toothed spatula TKB A4 (200/250 g/m²) to coat the defined area with an acrylic adhesive recommended by Tarkett.

Wait the appropriate tack time for the glue and then line up the first section with the plumb line and press in to place using a cork wedge (Refer to code 14, p. 23) and pushing air bubbles from top to bottom and centre to edges.

Glue the next area and hang the second section of wall covering (reversed when necessary) and either position tightly edge-to-edge with the first (make sure that the edges are in good condition) or overlapping the edges by around 3 cm. If you overlap the sheets, cut the joint using a hot air gun (Refer to code 1, p. 23) and a straight blade, or a combined scriber/marking gauge (Refer to code 1, p. 23).

INSIDE CORNER

To work round a corner, hang the wall covering up to the corner and fold it back on itself. Create a fold against the corner the full height of the sheet and then use an angle roller (Refer to code 2, p. 23) and taking care to press each side of the corner starting from the bottom. If the corner of the substrate isn't straight, cut the wall covering vertically at least 10 cm from the corner and continue with the next section.

OUTSIDE CORNER

Double glue an area 5 cm from each side of the edge using an acrylic double contact adhesive with a spatula or use an appropriate dry tape. Press the wall covering in to place on one side up to the corner. Use a hot air gun (Refer to code 1, p. 23) and bend the wall covering around the corner, pressing into the angle with a cloth and outside corner roller. If the substrate corner is not straight, cut the wall covering plumb 10 cm from the corner and continue with the next sheet.

6 COVERING THE COVING

Trim off the Aquarelle Wall HFS wall covering at 7cm or 10cm from the floor (a 3 cm overlap with the coving) using a combined scriber/marking gauge (Refer to code 11, p. 23).

NOTE

Excess material in the corner can be incorporated by using a hot air gun (Refer to code 1, p. 23) and corner roller (Refer to code 2, p. 23).

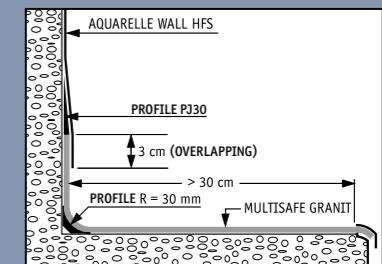

With cove former

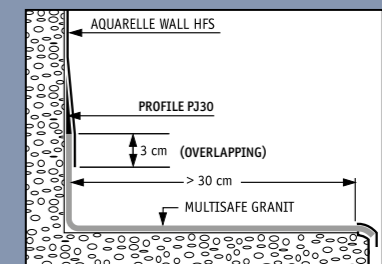

Heat formed without cove former

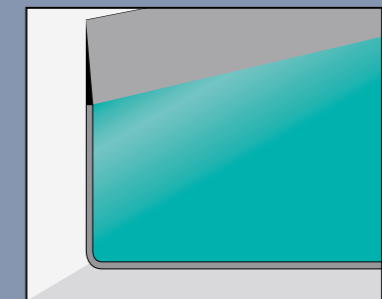

PJ 30

7 HOT WELDING THE JOINTS

Leave for 24-48 hours before hot welding the joints using welding rods as follows:

- Temperature of the substrate $\geq +12^{\circ}\text{C}$, ambient temperature $\geq +15^{\circ}\text{C}$

1 Open the joint using a grooving tool (Refer to code 3, p. 23) and a rule for support (Refer to code 4, p. 23).

2 Use the speed welding nozzle (Refer to code 5, p. 23) and work from top to bottom.

3 & 4 Use the Mozart knife (Refer to code 16, p. 23) or a quarter moon knife (Refer to code 6, p. 23) to trim in two stages, pre-trimming using an adjustable trimmer (Refer to code 7, p. 23) and finish with the quarter moon knife (Refer to code 6, p. 23).

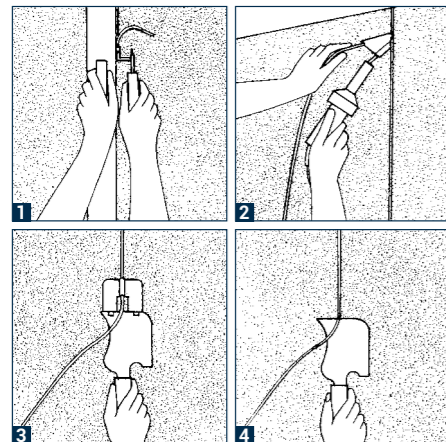

8 CAULKING

Once the floor and wall coverings are in place, waterproof the joints around the door frame (windows, frames, ceiling etc.) using a mastic designed for this purpose (polyurethane or MS polymer, Ref. Bostik MS 107). Do the same for any fixtures installed after the Aquarelle Wall HFS wall covering.

9 CONNECTING TO A DRY ROOM

In general: hot weld the floor covering to the flooring used in the adjacent room.

WETROOM THRESHOLD TRANSITION STRIP

Tarkett offers 2 types of threshold transition strips for use with the Wetroom concept.

RTS: Rubber threshold strip

> made from 10 cm wide grey rubber with a central air pocket that stops water and flattens easily under foot or wheels

> available in 20 ml reels

> fixed into place with a polyurethane adhesive and the floor coverings glued on to the 1 cm strip on either side using an acrylic adhesive

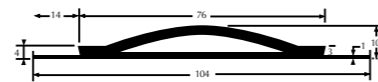

PTS: PVC threshold strip

> made from 9 cm wide solid pvc

> available in 4 colours

> available in 10 strips of 3 lm in a box

> may be hot welded with a welding rod for perfect water tightness

> fixed into place adhesive with a polyurethane adhesive and the floor coverings glued on to the 1 cm strip on either side using an acrylic adhesive

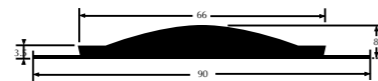

TOOLS REQUIRED

CODE	TYPE OF TOOL	FLOOR	WALL	JANSER	ROMUS
1	Hot air gun	X	X	226 110 000	95 047
2	Corner roller	X	X	224 400 123	95 135
3	Wall groover or adjustable groover		X		95 125
4	Guide rule		X	262 601 000	91 580
5	High speed hot air nozzle -	X	X	224 700 300	95 030
5	High speed nozzle	X	X	224 400 300	
5	Tarkett super high speed welding nozzle (Ref. 1258 012)		X		
6	Quarter moon knife	X	X	262 621 000	95 140
7	Adjustable trimmer	X	X	262 625 000	95 150
8	Traditional blowtorch	X	X	224 962 000	95 074
8	("welder")	X	X	224 818 000	95 080
9	or special wall seam plane (studded flooring)	X	X	262 626 500	95 172
9	or trimming tool slim		X	262 609 100	
9	or "slim" or "trim" trimmer		X	262 609 300	
10	90° angle template	X			95 445
10	and flat angle template for coving	X			95 446
11	Scriber or		X	222 430 000	95 430
11	combined scriber/marking gauge		X	262 130 000	
12	Swan neck nozzle or	X		224 810 040	95 039
12	Corner finishing nozzle	X		224 810 050	
13	Trimming gouge	X		262 610 000	95 160
14	cork wedge/squeegee	X	X	262 380 000	93 145
15	stainless steel trowel		X		93 150
16	Mozart knife	X	XX	262 636 000	95 130

RECOMMENDED ADHESIVES

Tarkett regularly test the main adhesives on the market to check that they are compatible with its products. The manufacturer is responsible for the quality of the adhesives and the installer for their use according to the manufacturer's instructions.

Acrylic adhesive should be applied using a fine toothed spatula TKB A4 (d.p.t 200 . 250 g/m²) for Aquarelle Wall HFS and TKB A2 (d.p.t environ 300 g/m²) for Multisafe Granit, Granit Safe. T and Multisafe Optima. Consideration should be given to the local climate in relation to tack time, drying etc.

TECHNICAL ASSISTANCE

If your business does not yet have experience in installing the Wetroom Concept please contact your local Tarkett sales office for advice and assistance.

PRODUCT DESCRIPTION

MULTISAFE OPTIMA

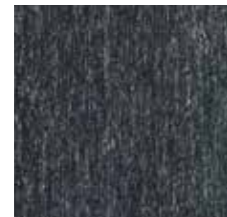

■ Is a studded homogeneous PVC flooring available in 2 m widths, 2 mm thick + 0.25 mm studs. It has slip resistance B as determined by bare feet on an angled ramp (angle $\geq 18^\circ$ according to standard DIN

51097). This flooring does not contribute to infection spreading. It has a 0.03 mm wear layer (NF eN 433).

■ Is 100 % recyclable and comes with a 10-year Guarantee. Emissions of volatile organic compounds (VOC) are lower than $10 \mu\text{g}/\text{m}^3$ (tVoc after 28 days).

GRANIT MULTISAFE



■ Is a studded homogeneous PVC flooring available in 2 m widths, 2 mm thick + 0.5 mm studs. It has slip resistance C as determined by bare feet on an angled ramp (angle $\geq 18^\circ$ according to standard DIN

51097). This flooring does not contribute to infection spreading. It has a 0.03 mm wear layer (according to NF EN 433).

■ Is 100 % recyclable and comes with a 10-year Guarantee. Emissions of volatile organic compounds (VOC) are lower than $10 \mu\text{g}/\text{m}^3$ (tVoc after 28 days).

MULTISAFE AQUA



■ Is a slip resistant heterogeneous vinyl flooring available in 2m width, 2mm thick. It has slip resistance Class C as determined by bare feet on an angled ramp (angle $\geq 24^\circ$ according to standard DIN

51097). The surface is strengthened and made easier to maintain by TopClean XP polyurethane surface treatment.

■ Is 100% recyclable and comes with a 10-year guarantee. Emissions of volatile organic compounds (VOC) are lower than $10 \mu\text{g}/\text{m}^3$ (TVOC after 28 days).

GRANIT SAFE.T



■ Is a slip resistant homogeneous PVC flooring available in 2 m widths, 2 mm thick. It has slip resistance class B as determined by bare feet on an angled ramp (angle $\geq 18^\circ$ according to standard DIN

51097). The surface is strengthened and made easier to maintain by Safety Clean XP, a photoreticulated polyurethane treatment. This flooring does not contribute to infection spreading. It has a 0.03 mm wear layer (NF eN 433).

■ Is 100 % recyclable and comes with a 10-year Guarantee. Emissions of volatile organic compounds (VOC) are lower than $10 \mu\text{g}/\text{m}^3$ (tVoc after 28 days).

AQUARELLE WALL HFS



■ Is a PVC wall covering especially suitable for use in wet areas. This flooring does not contribute to infection spreading. It is available in 2 m widths and is 0.92 mm thick.

WALL BORDER

■ The PVC wall border is especially suitable for use in wet areas. It helps preventing infection spreading. It comes in lengths 0.49 m x 30 ml and is 0.92 mm thick.

TARKOMOUSSE

■ Is a glass fibre reinforced PVC underlay with a foam underside. Used with a floor covering, it offers acoustic reductions of 19 dB with Multisafe Granit and 17 db with Granit Safe.T and Multisafe Aqua (Technical data and installation instructions are available upon request). It comes in 2 meter widths.

TECHNICAL DATA

TECHNICAL DATA	STANDARD	AQUARELLE WALL HFS	GRANIT MULTISAFE	OPTIMA MULTISAFE	GRANIT SAFE.T	MULTISAFE AQUA
CLASSIFICATION						
Classification	EN 233	Homogeneous vinyl compact wall covering	-	-	-	-
	EN 649	-	Homogeneous single layered vinyl flooring with studded surface	Homogeneous vinyl flooring with studded surface	-	-
	ISO 10582	-	-	-	-	Heterogeneous vinyl floor covering
	EN 13845	-	-	-	Slip resistant homogeneous vinyl flooring	-
	EN ISO 10874	-	Commercial: 31	Commercial: 31	Commercial: 34 / Industrial: 43	Commercial: 33 / Industrial: 42
Wear layer binder content	EN ISO 10581	-	Type I	Type I	-	Type I
TECHNICAL CHARACTERISTICS						
Total thickness	EN ISO 24346	0.92 mm	2.5 mm	2.25 mm	2.0 mm	0.55 mm
Total weight	EN ISO 23997	1500 g/m ²	3010 g/m ²	2820 g/m ²	2950 g/m ²	3100 g/m ²
Wear layer thickness	EN ISO 24340	0.12 mm	2.0 mm	2.0 mm	2.0 mm	2.0 mm
Surface treatment	EN ISO 24340	-	-	-	Safe.T Clean XP*	Top Clean XP*
Form of delivery	EN ISO 24341 Sheet (rolls)	Rolls: 35 lm x 2 m Borders: 49 cm x 30-35 m	25 lm x 2 m	25 lm x 2 m	25 lm x 2 m	20 lm x 2 m
PERFORMANCES FOR CE MARKING REQUIREMENTS (EN 14041)						
Declaration of Performance	EN 14041	0131-0032-DoP-2013-07	0019-0034-DoP-2013-07	0019-0036-DoP-2013-07	0019-0006-DoP-2013-07	0120-0054-DoP-2014-05
Reaction to fire	EN 13501-1	B-s2,d0 on any non-metal A1 or A2-s1,d0 class substrate	Class Bfl-s1	Class Bfl-s1	Class Bfl-s1	Bfl-s1 glued over any A2fl or A1fl substrate (on cement) Cfl-s1 glued over any derivative wood substrate
	EN 13501-1	-	$\geq 8 \text{ kW}/\text{m}^2$	$\geq 8 \text{ kW}/\text{m}^2$	$\geq 8 \text{ kW}/\text{m}^2$	-
	EN ISO 11925-2	-	Pass	Pass	Pass	-
Marine equipment	IMO FTPS Part 5 and 2 IMO Res. A653	-		-	-	-
Static electrical discharge	EN 1815	-	< 2 kV	< 2 kV	< 2 kV	< 2 kV Antistatic on concrete
Thermal resistance	EN 12667	-	Approx. 0.01 m ² K/W	Approx. 0.01 m ² K/W	Approx. 0.01 m ² K/W	Approx. 0.02 m ² K/W
Slip resistance	EN 13893	-	$\mu \geq 0.3$	$\mu \geq 0.3$	$\mu \geq 0.3$	$\mu \geq 0.3$
TECHNICAL PERFORMANCES						
Residual indentation	EN ISO 24343-1	-	Required value: $\leq 0.10 \text{ mm}$ Average measured value*: 0.02 mm	Required value: $\leq 0.10 \text{ mm}$ Average measured value*: 0.02 mm	Required value: $\leq 0.10 \text{ mm}$ Average measured value*: 0.02 mm	Required value: $\leq 0.10 \text{ mm}$ Average measured value*: 0.03 mm
Slip resistance	DIN 51130	-	R10	R10	R10	-
Bare foot test	DIN 51097	-	Class C (27°)	Class B (18°)	Class B (18°)	Class C (27°)
Curl resistance to heat	EN ISO 23999	-	Yes	Yes	Yes	$\leq 8 \text{ mm}$
Castor chair test	ISO 4918	-	-	-	Suitable	No damage (25000 cycles)
Light fastness	EN ISO 105-B02	≥ 6	≥ 6	≥ 6	≥ 6	≥ 6
Chemical resistance	EN ISO 26987	Good	Good	Good	Good	Good
Electrical resistance	EN 1081	-	approx. 10^{10} Ohm	approx. 10^{10} Ohm	-	-
Bacteria resistance	ISO 846 Part C	-	Does not favour growth	Does not favour growth	Does not favour growth	-
Underfloor heating	-	-	Suitable - max. 27°C	Suitable - max. 27°C	Suitable - max. 27°C	Suitable - max. 27°C
Seam strength	EN 684	$\geq 150 \text{ N}/50 \text{ mm}$	Average value: $\geq 240 \text{ N}/50 \text{ mm}$ Individual values: $\geq 180 \text{ N}/50 \text{ mm}$	Average value: $\geq 240 \text{ N}/50 \text{ mm}$ Individual values: $\geq 180 \text{ N}/50 \text{ mm}$	Average value: $\geq 240 \text{ N}/50 \text{ mm}$ Individual values: $\geq 180 \text{ N}/50 \text{ mm}$	Average value: $\geq 240 \text{ N}/50 \text{ mm}$
ENVIRONMENTAL PERFORMANCES						
Total VOC emissions	ISO 16000-9	$\leq 10 \mu\text{g}/\text{m}^3$ (after 28 days)	$\leq 10 \mu\text{g}/\text{m}^3$ (after 28 days)	$\leq 10 \mu\text{g}/\text{m}^3$ (after 28 days)	$\leq 10 \mu\text{g}/\text{m}^3$ (after 28 days)	$\leq 10 \mu\text{g}/\text{m}^3$ (after 28 days)
COLOURS						
		27	16	12	16	11

The above information is subject to modification for the benefit of further improvement. (05/19). *For information - not binding.

According to the European Regulation N° 305/2011 for CE Marking, the Declarations of Performance are available on our website www.tarkett.com

Tarkett's instructions regarding installation, cleaning and maintenance should be observed. Please contact Tarkett at the address shown for these instructions.



REFERENCE CODES

REFERENCES	PLAIN WELDING RODS	MULTICOLOUR WELDING RODS	NCS	LUMINOUS REFLECTANCE VALUES
GRANIT MULTISAFE				
3476 379	1292379	1290041	S 4030-R90B	20.37 %
3476 382	1292 811	1290 028	NCS S 2502-B	49.05%
3476 383	1292 383	1290 021	NCS S 4502-B	28.60%
3476 740	1291542	1290149	S 5502-B	21.36 %
3476 741	1287255	1290150	S 3000-N	45.26 %
3476 742	1287446	1290151	S 1500-N	65.17 %
3476 743	1287391	1290143	S 3010 Y30R	41.32 %
3476 744	1287039	1290147	S 2010-Y20R	52.20 %
3476 745	1287178	1290146	S 3005-Y20R	42.38 %
3476 746	1287537	1290144	S 5005-Y20R	25.32 %
3476 747	1287519	1290148	S 2050-Y40R	35.84 %
3476 748	1287514	1290112	S 3030-R90B	27.91 %
3476 749	1287509	1290107	S 2030 B10G	40.24 %
3476 750	1287518	1290116	S 2030-G50Y	48.05 %
3476 751	1287298	1290070	S 1040-Y20R	59.81 %
3476 770	1288 255	1290 036	NCS S 1005-Y40R	71.32%
OPTIMA MULTISAFE				
3240 820	1287501	1290099	S 4010-Y30R	32.00 %
3240 838	1287509	1290107	S 2020-B10G	44.09 %
3240 845	1291845	1290034	S 8502-B	6.20 %
3240 848	1287514	1290112	S 3030-R80B	26.56 %
3240 853	1292388	1290022	S 3502-B	37.12 %
3240 860	1287039	1290066	S 2010-Y20R	52.20 %
3240 861	1287518	1290116	S 2040-G60Y	45.24 %
3240 863	1287519	1290117	S 2050-Y40R	35.84 %
3240 866	1291216	1290026	S 6502-B	15.11 %
3240 873	1287524	1290122	S 3502-Y	38.15 %
3240 874	1287525	1290123	S 5502-Y	21.62 %
3240 886	1291609	1290049	S 1500-N	65.17 %
GRANIT SAFE.T				
3052 690	1287249	1290056	S 1040-Y30R	56.37 %
3052 691	1288255	1290036	S 1005-Y40R	71.32 %
3052 692	1287407	1290023	S 2010-Y30R	56.23 %
3052 693	1292375	1290046	S 3030-Y50R	31.53 %
3052 694	1287332	1290059	S 3020-G30Y	36.90 %
3052 695	1291210	1290038	S 2020-R90B	44.17 %
3052 696	1292379	1290041	S 4030-R90B	20.37 %
3052 697	1291811	1290028	S 2502-B	49.05 %
3052 698	1292383	1290021	S 4502-B	28.60 %
3052 699	1299327	1290027	S 6502-B	15.10 %
3052 700	1292384	1290035	S 8502-B	6.20 %
3052 702	1287391	1290143	S 3010 Y30R	41.32 %
3052 703	1287298	1290070	S 1040-Y20R	59.81 %
3052 704	1287537	1290144	S 5005-Y20R	25.32 %
3052 705	1287298	1290070	S 2030-G50Y	48.05 %
3052 706	1287509	1290107	S 2030 B10G	40.24 %

REFERENCES	PLAIN WELDING RODS	NCS	LUMINOUS REFLECTANCE VALUES	LAYING DIRECTION
MULTISAFE AQUA				
25910 000	24806 090	S1505-Y40R	55,92 %	Reverse
25910 001	24806 091	S3502-Y	36,48 %	Reverse
25910 002	24806 092	S4502-Y	24,2 %	Reverse
25912 202	24806 099	S4005-Y50R	27,53 %	Same direction
25912 203	24806 098	S3020-Y10R	37,77 %	Same direction
25910 007	1287 836	S 6500-N	13,2 %	Reverse
25910 008	1287 870	S 6005-Y20R	18,8 %	Reverse
25910 009	1287 530	S 3005-Y50R	37,3 %	Reverse
25910 010	1287027	S 3000-N	40,8 %	Reverse
25910 011	1292770	S 2502-Y	39,6 %	Reverse
25910 013	1287 218	S 3020-B90G	34,6 %	Reverse
AQUARELLE WALL HFS				
3942 027	24806 013	S 0510-Y20R	67.10 %	Reverse
3942 033	24806 015	S 1000-N	68.70 %	Reverse
3942 034	24806 016	S 0500-N	71.30 %	Reverse
3942 037	24806 017	S 0300-N	80.30 %	Reverse
3942 040	24806 009	S 0603-Y20R	73.80 %	Reverse
3942 041	24806 002	S 2005-Y50R	47.50 %	Reverse
3942 042	24806 004	S 6005-Y50R	12.80 %	Reverse
3942 043	24806 003	S 3500N	28.40 %	Reverse
3942 044	24806 006	S 7000N	9.70 %	Reverse
3942 047	24806 010	S 1040-G60Y	50.40 %	Reverse
3942 048	24806 011	S 1070-Y50R	31.30 %	Reverse
3942 050	24806 018	S 1500-N	55.30 %	Reverse
3942 051	24806 019	S 3502-B	34.10 %	Reverse
3942 052	24806 020	S 2002-Y	47.70 %	Reverse
3942 053	24806 021	S 3502-Y	30.10 %	Reverse
3942 054	24806 022	S 1510-Y10R	55.80 %	Reverse
3942 057	24806 025	S 2020-R80B	43.20 %	Reverse
3942 058	24806 026	S 0500-N	68.50 %	Reverse
3942 059	24806 027	S 2005-Y20R	39.50 %	Reverse
3942 061	24806 029	S 5005-Y50R	24.90 %	Reverse
3942 076	24806 144	S 1010 - G	66,89 %	Reverse
3942 077	24806 156	S 2005 - B	57,09 %	Reverse
3942 078	24806 114	S 4010 - Y10R	26,0 %	Reverse
3942079	24806 124	S 0500 - N	78,88 %	Same direction
3942 080	24806 134	Fond: S 0502 - Y50R Motif: S 1002 - G50Y	75,09 %	Same direction
3942081	24806 121	Fond: S 1002 - Y50R Motif: S 1502 - Y50R	65,6 %	Same direction
3942 082	24806 159	S 5010 - B30G	19,13 %	Reverse

GUARANTEE

APPLICATION

The 10-year guarantee runs from receipt of the product by the contractor, on condition that the work is carried out according to the specifications and Technical Assessment.

The Wetroom Concept is a Technical Assessment (n°12/11-1599) procedure on the green list (without observation) of the Construction Quality Agency's (AQC) Product Safety Commission (C2P). A 10-year insurance policy is therefore required and applied without any additional conditions (consult your own insurance contract). Tarkett's Wetroom Concept is covered by a 10-year guarantee (construction material manufacturers) with AXA insurance.

CONTRACTORS

The success of the Wetroom concept rests on more than 25 years of high quality installations. We recommend that contractors only use installers with experience in the Wetroom concept.



MAINTENANCE

FLOORING CARE: MULTISAFE GRANIT OR GRANIT SAFE.T OR MULTISAFE OPTIMA

BEFORE USE

Vacuum clean the flooring.
Clean with an alkaline (pH 8/10) detergent and a scrubbing brush or a low speed cleaning machine with a nylon brush.
Rinse with clean water.

DAILY CARE

Wash by hand with a neutral (pH 6/8) detergent. Periodic care/Return to original condition.
Wash with an alkaline (pH 8/10) detergent and a scrubbing brush or a low speed cleaning machine with a nylon brush.
Rinse with clean water.

RECOMMENDED PRODUCTS

Neutral detergent: Jontec Asset, 300 (Diversey), Dynatech Clean Force (Tana Professional), or similar
Alkaline detergent: Jontec Stride Degreaser (Diversey), Dynatech Alka (Tana Professional), or similar
Descaling detergent: Sani Acid (Diversey), Dynatech Calc Off (Tana Professional), or similar
Disinfectant detergent: Sprint Degragerm (Diversey), Dynatech Clean Bacto (Tana Professional), or similar.

WALL COVERING CARE: AQUARELLE WALL HFS

Wash with a neutral (pH 6/8) detergent. Don't use an abrasive pad.
Rinse with fresh water.

■ **WESTERN EUROPE:** Austria: Tarkett Holding GmbH, Niederlassung Wien – Tel. +43 1 47 88 062 • Belgium: Tarkett Belux N.V. – Tel. +32 52 26 24 11 • Denmark: Tarkett A/S – Tel. +45 43 90 60 11 • Finland: Tarkett Oy – Tel. +358 9 4257 9000
■ France: Tarkett SAS – Tel. +33 1 41 20 42 49 • Germany: Tarkett Holding GmbH – Tel. +49 62 33 810 • Greece: Tarkett Monoprosopi Ltd – Tel. +30 210 6745 340 • Italy: Tarkett S.p.A. – Tel. +39 0744 7551 • Luxembourg: Tarkett Belux N.V. – Tel. +32 52 26 24 11 • Netherlands: Tarkett BV – Tel. +31 416 685 491 • Norway: Tarkett AS – Tel. +47 32 20 92 00 • Portugal: Tarkett SA – Tel. +351 21 427 64 20 • Spain: Tarkett Floors S.L. – Tel. +34 91 358 00 35 • Sweden: Tarkett Sverige AB – Tel. +46 771 25 19 00 • Switzerland: Tarkett Holding GmbH – Tel. +41 043 233 79 24 • Turkey: Tarkett Aspen - Tel. +90 212 213 65 80 • United Kingdom: Tarkett Ltd – Tel. +44 (0) 1622 854 040 ■ **EASTERN EUROPE: Baltic Countries:** Tarkett Baltics: Tel. +370 37 262 220 • Czech Republic: Tarkett org. složka – Tel. +420 271 001 600 • Hungary: Tarkett Polska SP Z.O.O. magyarországi fióktelepe – Tel. +36 1 437 8150 • Poland: Tarkett Polska Sp. z o. o. – Tel. +48 22 16 09 231 • Russian Federation: ZAO Tarkett RUS - Tel. +7 495 775 3737 • Slovakia: Tarkett Polska, organizačná zložka – Tel. +421 2 48291 317 • South East Europe: Tarkett SEE – Tel. +381 21 7557 649 (44) 569 12 21 • Ukraine: Tarkett UA – Tel. +38 (0) 44 569 12 21 ■ **ASIA AND OCEANIA:** Australia: Tarkett Australia Pty Ltd – Tel. +61 2 88 53 12 00 • China: Tarkett Floor Covering (Shanghai) Co. Ltd. – Tel. +86 (21) 60 95 68 38 ext 841 • North East Asia: Tarkett Hong Kong Limited – Tel. +852 2511 8716 • India: Tarkett Flooring India Pvt. Ltd. – Bangalore - Tel. +91 80 4130 3793 – New Delhi - Tel. +91 11 4352 4073 – Mumbai - Tel. +91 22 2648 8750 • South East Asia: Tarkett Flooring Singapore Pte. Ltd. – Tel. +65 6346 1585 ■ **AFRICA:** Tarkett International: Tel. +33 1 41 20 41 01 ■ **MIDDLE EAST:** Tarkett Middle East: Tel. +961 1 51 3363/4 • Israël: Tarkett International: Tel. +33 1 41 20 41 01 ■ **NORTH AMERICA:** USA: Tarkett Inc. – Tel. +1 713 869 5811 / Johnsonite – Tel. +1 440 543 8916 • Canada: Tarkett Inc. – Tel. +1 450 293 173 ■ **LATIN AMERICA:** Brazil: Tarkett - Tel. 55 12 3954 7108 • Argentina - Chile - Uruguay: Tarkett Latam Mercosur - Tel. +54 11 47 08 07 72 / +549 11 44 46 88 82 • Bolivia - Colombia - Ecuador - Panama - Paraguay - Peru - Trinidad and Tobago - Venezuela: Tarkett - Tel. +55 11 9 8410 9310 / +55 11 95494 0069 • Mexico / Central America: Tarkett Latam Mexico - Tel. +55 11 98410 9310

The designs and photos used in this brochure are for illustration purposes only.
They are not contractual images and do not stand for product recommendation.
Design: Agence Gecko/ Photo: XXX / Print: XXX

www.professionals.tarkett.com

